



**Westfälische  
Hochschule**

**University of Applied Sciences**  
Gelsenkirchen Bocholt Recklinghausen

# **Research and Development** at the Westphalian University

## **Research Report**

# Content

- 3** Foreword
- 4** Innovations in medical technology in the context of the NUB procedure
- 5** Development of new nanocoated powder materials and tribologically optimised micro- and nanostructured multilayer high-performance coatings
- 6** Efficient energy conversion with fuel cells  
Modular fuel cell in pocket design
- 7** Model-based leak monitoring  
State-of-the-art in leak detection and localization
- 8** Optimisation of process organisation through use of more efficient IT in hospitals
- 9** Entrepreneurial Diversity  
Facets of the image of women entrepreneurs in Germany
- 10** Telemedicine:  
Set for the transition from research to broad-based application
- 11** Jatropha nuts  
Energy use of wild plants
- 12** IHMoS  
Intelligent Hand Hygiene Monitoring System
- 13** CityGML-Toolchain  
Development and application scenarios for 3D urban models
- 14** Service quality in mode choice modelling for regional transport
- 15** Nanoparticle-based solvent-free polymer reactive dispersions
- 16** An educational jungle in NRW between school, vocational training and work Programmes, educational courses and other measures in the transition system
- 17** Admotional  
Better online advertisements through personalised banners
- 18** Individual anatomical implantation of shoulder endoprotheses through ultrasound volumetric imaging-based preoperative planning and intraoperative navigation
- 19** Botnets  
One of the greatest dangers on the internet
- 20** Reduction in particulate emissions from smallscale combustion plants using conventional and electrostatically charged scrubbers
- 21** Innovation strategies in the construction industry - An international comparison
- 22** Reporting on robot innovations and autonomous systems
- 23** ELMO<sup>S</sup> - Electromobility solutions for cities and regions
- 24** Business analytics for SMEs - Raising corporate value through target groupspecific customer value management
- 25** Biofunctionalisation of surfaces with proteins  
Molecular building blocks from the bionanotechnology domain
- 26** The Westphalian Institute of Health at the Westphalian University of Applied Sciences

For more information and current publications,  
see using [www.w-hs.de/kooperieren/forschung-und-entwicklung/forschungsbericht/](http://www.w-hs.de/kooperieren/forschung-und-entwicklung/forschungsbericht/)

# Foreword

## **The Westphalian University of Applied Sciences – A university in transformation**

In March 2012, the former “Fachhochschule Gelsenkirchen” became the new “Westfälische Hochschule” - the Westphalian University of Applied Sciences. The new regional name for our university is an expression of the shared identity and sense of belonging together of our sites at Gelsenkirchen, Bocholt and Recklinghausen. The departments, too, have drawn closer together. As a result, the former 12 faculties have now been reduced to 8, with the aim of strengthening the interdisciplinary collaboration in both research and teaching.

The past year already saw the foundation of the Westphalian Institute of Health (“Westfälisches Institut für Gesundheit” or “WIGE”, for short) and the Westphalian Energy Institute (“Westfälisches Energieinstitut” or “WEI”), both of which, alongside the other already established research institutes such as the Bocholt Mechatronics Institute (“Mechatronik-Institut Bocholt” or “MIB”) and the Institute of Internet Security (“Institut für Internetsicherheit” or “IFIS”), are already key pillars in our trans-departmental research activities. In its institutes, the Westphalian University pools the research activities of the university in specific areas. In WIGE 15 and WEI 22, for example, professors work jointly with their assistants and postgraduate research students on topics in the fields of health and energy.

## **Research to help people**

In a region that finds itself in the middle of a process of structural change, it becomes especially clear how important it is to be able to respond flexibly to the challenges of the future. Not so many years, when people stopped working, they retired from the job they had trained for decades before; nowadays, people are often expected to move to another profession in mid-career. The resulting demand for breadth of training and continuous further training of people must be also duly taken into account, particularly in the field of academic basic and further training. Application-oriented research provides important assistance in the search for topical questions and their impact on training/education, and also research itself. In this process, applied research must constantly ask itself whether it is serving the needs of people and whether it contributes to answering the pressing questions of our society and in particular of the people in the region. Already from the names of the institutes - the Westphalian Institute of Health, the Institute of Internet Security or the Westphalian Energy Institute - it is obvious that the researchers there are engaged in issues of high topicality. They include, for instance, life in advancing age and living life with the Internet or, in a different sphere, the question of energy supply concepts of future, with special reference to hydrogen-based energy systems.

If these research efforts are also rewarded with prizes, as clearly emerges at various points in the following reports, it is possible to speak justifiably of successful, responsible research.

I would like to take this opportunity to express my great respect and most sincere thanks to all the people at our university who devote themselves with untiring energy to this kind of research!

On behalf of the Head of the Westphalian University of Applied Sciences



**Prof. Dr.  
Michael Brodmann**  
Vice-President

**Michael Brodmann**  
Vice-President Research and Development

# Innovations in medical technology

## in the context of the NUB procedure

The DRG system<sup>1</sup> for funding the services of hospitals is based on calculation of the costs of existing medical treatments. Under the NUB procedure (short for “Neue Untersuchungs- und Behandlungsmethoden”, i.e. New Examination and Treatment Methods) it has also been possible since 2005 for progress in the field of medical technology to be reflected in the DRG system.

### Results for the NUB procedure

Between 2006 and 2010, 45,000 applications were made to InEK (“Institut für das Entgeltsystem im Krankenhaus”), the Institute for the Hospital Remuneration System in Germany, for the recognition and approval of innovations, 22,907 of which were granted. The number of applications submitted by hospitals and the number of applications approved gives rise to the impression that innovations are rapidly diffused (see table). The actual innovation potential is expressed primarily in the number of procedures. However, as a new application has to be made every year, most of the applications are repeats. The number of approved applications amounts to only 364, submitted by only a small number of hospitals.

### Diffusion of innovations in patient care

To analyse the diffusion of innovations spread, the OPS statistics at national level in Germany and the quality reports of the hospitals were evaluated. In 2006, only 0.05% were accounted for by procedures approved under NUB, and from 2007 to 2009 only 0.007%. It can be shown with examples that while innovative procedures with a relatively high level of specialisation do indeed find their way into the financing system through NUB, the actual diffusion takes place through specialised centres and is hindered by the professional and organisational requirements. Greater diffusion is achieved by innovations that improve or replace existing methods.

Table: Number of NUB applications submitted by hospitals (NUB = 2,971)**						
Status	Year					Total
	2006	2007	2008	2009	2010	
0*	116	80	81	135	367	779
1	1,507	2,312	4,258	7,480	7,350	22,907
2	2,141	2,340	3,797	6,005	6,737	21,020
4	93	332	76	245	372	1,118
<b>Total</b>	<b>3,857</b>	<b>5,064</b>	<b>8,212</b>	<b>13,865</b>	<b>14,826</b>	<b>45,824</b>

\* Status open or multiple  
\*\* Including repeat applications

Source: InEK: Information under § 6 (2) KHEntgG [German Hospital Remuneration Act] for 2006 to 2009; own computations

During the period from 2006 to 2010, around 45,000 applications were submitted.

The interest of the hospitals in innovations is indicated by the rise in the number of entries.

### Summary

The NUB procedure represents only one element in the innovation regime operating in the field of medical technology. It is one of the contributory factors that result in innovations only finding their way into the health system on a limited scale. The system is characterised by a diversity of influences and factors, including qualification requirements, organisational requirements and the level of novelty of the innovation. Recognition under the NUB procedure is far from meaning automatic diffusion of an innovation. And conversely, rejection does not necessarily mean that an innovation will not become established. However, the complexity of the procedure constitutes a relatively high hurdle to the introduction of technological progress. There is no empirical confirmation for the concern that the procedure may be associated with high costs and risks.

<sup>1</sup> DRG – Diagnosis-related case groups; DRG system: A billing and remuneration system under which inpatient hospital treatment is charged for on the basis of flat-rate payments for defined medical conditions, largely without reference to the length of a patient’s hospital stay.

### Project information//

[www.iat.eu](http://www.iat.eu)

### Contact//

Stephan von Bandemer  
Institut Arbeit und Technik, IAT  
[Institute for Work and Technology]  
Tel.: +49 209 1707-115  
[bandemer@iat.eu](mailto:bandemer@iat.eu)



# Development of new nanocoated powder materials and tribologically optimised micro- and nanostructured multilayer high-performance coatings

There is a major demand for the further development of corrosion-proof and wear-resistant high-performance coatings on critical components such as turbines, undercarriages, heavy-duty pumps, engines, tools etc. To this end, so-called hard chrome replacement coatings need to be technologically optimised and their production costs reduced. The use of extremely fine powder materials for coating by means of high-speed flame-spraying methods offers technological benefits. Fine particles need less time to absorb the energy needed for coating and are therefore especially suited for internal coating applications. Moreover, the microporosity of the layers is reduced through systematically smaller individual particles layers, which offer better protection against electrolyte penetration and hence also against crevice, interfacial and undercorrosion.

Micro- and nanostructured coating powders, the further-developed process technology and the resulting high-performance coatings have the purpose of extending the service life of components and systems. To offer similarly effective and at the same time affordable alternative processes to galvanic chrome deposition, a powder material has been developed which is suitable for both internal and external near-net-shape coating applications. In contrast to conventional HVOF spraying methods, the new coatings can be sprayed with only little excess. This therefore reduces the necessary material input, costly mechanical reworking and the costs of the coating process.

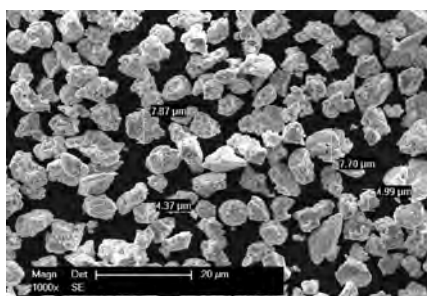
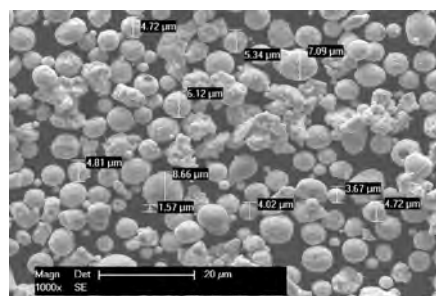

REM images of the new spray powder (left) and the agglomerated, sintered and fractured powder prior to processing (right) (1000x SE, scanning electron microscope images)

## Plasma spheroidised powders

The powders are initially agglomerated, sintered and fractured, with a chunky, uneven particle shape. Other unwanted characteristics, such as the high agglomeration propensity and inadequate pouring properties, result from the small grain size of 9 to 1 µm and the particle shape. Such powders are not suitable for the creation of dense, near-net-shape coatings. Using an axial plasma process, the carbide metal matrix composite powders, made up of 86% tungsten carbide, 10% cobalt and 4% chrome, were spheroidised. The resulting spherical shape of the particles reduces the agglomeration propensity and improves the pourability.

The fine, spheroidised powders even adhere to polished surfaces. To some degree, therefore, it is possible to do without surface roughening or blast cleaning.

## Project information//

Project partners in the project: Thermico GmbH & Co. KG (Dortmund), Institute for Metal-Cutting Manufacturing (ISF, TU Dortmund), Chair of Materials Technology (LWT, TU Dortmund), Materials Science and Materials Testing (Westphalian University of Applied Sciences, Gelsenkirchen) The project was funded under the NRW Objective 2 Programme (EFRE) 2007-2013.

## Contact//

Prof. Dr. Waltraut Brandl  
Westfälisches Energieinstitut  
[Westphalian Energy Institute]  
Tel.: +49 209 9596-168  
waltraut.brandl@w-hs.de

# Efficient energy conversion with fuel cells

## Modular fuel cell in pocket design

Hydrogen technology is seen as offering major potential in the field of energy storage. One key element in a hydrogen-based energy system are fuel cells which are able to efficiently convert the chemical energy stored in the hydrogen into electrical energy. One major step in the further development of fuel cell technology is the "modular fuel cell stack concept in pocket design" which has been developed at the Westphalian University of Applied Sciences. One goal of the development was to avoid the drawbacks of mechanical pressurisation and non-all-over cooling.

Thanks to modularisation, it is possible to achieve a maintenance capability that is both technically uncomplicated and economically affordable, and so extend the overall service life of a system. Wearing parts can be easily and safely exchanged, and the result is a "repairable fuel cell system". The switch to hydraulic pressurisation solves the problems of uneven tension, and the modularity based on single cells in conjunction with the surrounding hydraulic medium ensures optimum cooling conditions for each cell.

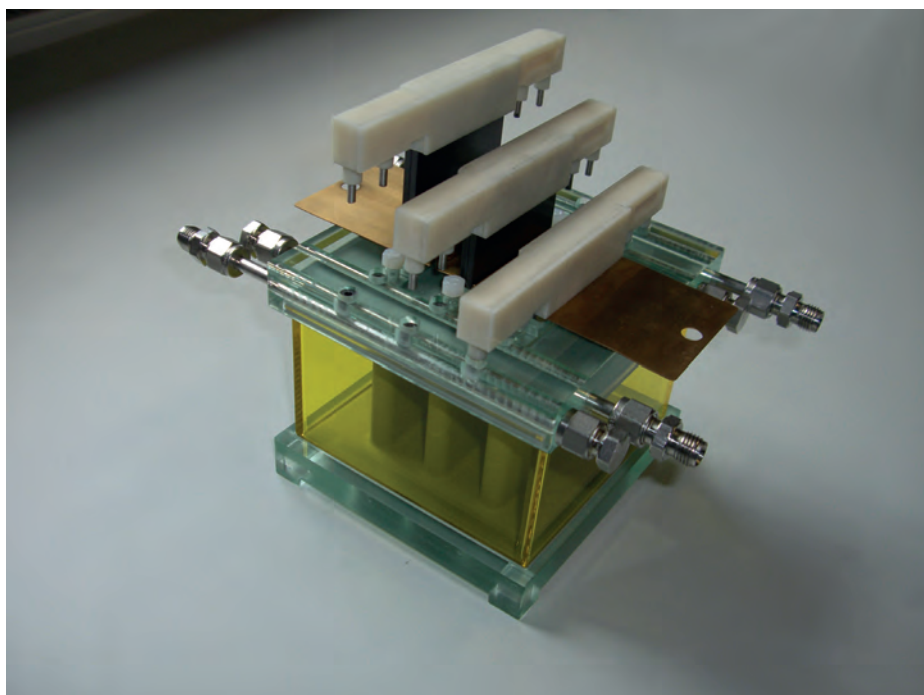

Prototype of the pocket stack (three cells)

### System design

The fuel cells are slid into the pockets of a flexible membrane. The electrical connections of the fuel cells and the supply of fuel (hydrogen and oxygen from the air) are handled by a central utility panel. Each individual cell consists of two pole plates with an internal membrane/electrode unit, the gas diffusion layers and the seals. The clip system located at the top enables the supply and disposal of the media. The clip forms the connection for the gas supply between the individual fuel cell and the utility panel. To enable tool-free final assembly of the stack, the individual cells are slid into the housing slots, whereby the clips click into place in the gas-bearing utility panel.

Hydraulic fluid in the pressure housing provides even contact pressure, and by completely surrounding the cells, ensures even cooling of each fuel cell at the same time. The organisation of the fuel cells in separate pockets enables easy exchange of individual cells and also ease of repair and maintenance.

### Potential applications

Because of its modular design, this system, for which patents have been applied, is particularly suited for stationary applications with long service lives, e.g. as fuel cell heating devices. The excess energy of the fuel cells can be easily removed with the aid of the hydraulic fluid and put to other uses.

### Project information //

[www.energie.w-hs.de](http://www.energie.w-hs.de)

### Contact//

Prof. Dr. Michael Brodmann  
Westfälisches Energieinstitut  
[Westphalian Energy Institute]  
Tel.: +49 209 9596-828  
[michael.brodmann@w-hs.de](mailto:michael.brodmann@w-hs.de)

# Model-based leak monitoring

## State-of-the-art in leak detection and localization

Leak monitoring systems are used wherever liquids and gases are stored, transported or processed. Many fluids transported by pipelines are hazardous; it is therefore often necessary to consider legal regulations such as the Technical Rules for Pipelines ("Technische Regel für Rohrfernleitungen", TRFL) in Germany.

### External leak monitoring

External leak monitoring systems use dedicated sensors, such as acoustic detectors. These operate on the principle that escaping fluids generate an acoustic signal that deviates from the baseline, i.e. the "acoustic fingerprint".

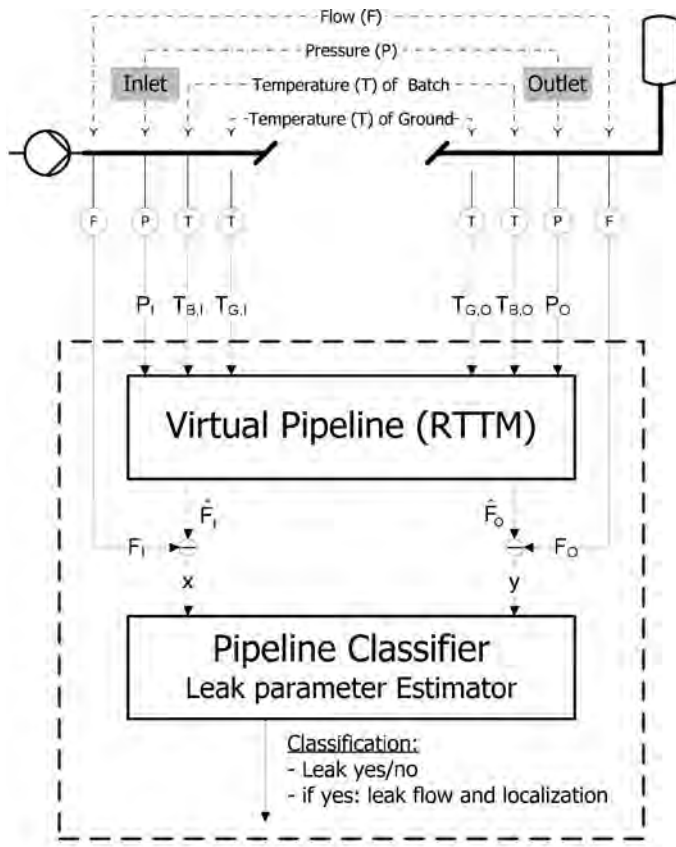

Model-based leak detection and leak location using the Extended RTTM (E-RTTM) method.

### Internal leak monitoring

Internal leak monitoring systems use sensors for field variables such as flow, pressure and temperature in order to detect a leak. The state-of-the-art in this area are mass and volume balance methods as well as methods based on Real-Time Transient Models (RTTM). RTTM-based systems compensate for transient effects caused by fluid compressibility and pipeline elasticity; leak detection and leak location is therefore also possible during transient operation, e.g. during start-up. Leak monitoring during transient operation is state-of-the-art and therefore also required by the TRFL.

### Model-based leak detection and leak location

Within the research project "Model-Based Leak Monitoring", methods and systems for the model-based leak detection and localization are developed and evaluated. The combination of RTTM methods and statistical pattern recognition methods greatly improves performance, reliability and robustness. These new methods extend well-known RTTM methods and are therefore referred to as Extended RTTM (or E-RTTM) methods. As the first step, a so-called "virtual pipeline" is used as the RTTM module. Basing on pressure  $P$  and temperature  $T$ , this module calculates the "virtual" mass flows (at inlet and outlet) assuming a leak-free pipeline. Comparison with the actual measured mass flows yields the residuals  $x$  and  $y$  containing the information about the leak state of the pipeline. These residuals are subsequently passed to a second step, the "Pipeline Classifier" which uses statistical pattern recognition methods for leak detection (leak yes/no) and leak parameter estimation (leak flow and position).

This research work is carried out together with KROHNE Messtechnik in Duisburg. A 200 meter pilot pipeline is available for testing and evaluation.

### Project information//

Supported by KROHNE Messtechnik in Duisburg.  
[www.krohne.com/en/products/systems/pipepatrol/](http://www.krohne.com/en/products/systems/pipepatrol/)

### Contact//

Prof. Dr. Gerhard Geiger  
 Westfälisches Energieinstitut  
 [Westphalian Energy Institute]  
 Tel.: +49 209 9596-239  
[gerhard.geiger@w-hs.de](mailto:gerhard.geiger@w-hs.de)

# Optimisation of process organisation through use of more efficient IT in hospitals

On the basis of scientific research into work processes in a variety of health service institutions, the Institute for Workflow Management in Health (IWiG) has devised a 5-phase model. The IWiG model describes a holistic workflow management system for the documentation, analysis and continuous improvement of processes. In particular, tools, processes and technologies have been developed for implementing this approach.

## ClipMed

The prerequisites for successful process organisation are an appropriate approach to the analysis, optimisation and implementation of the treatment processes and the use of process-oriented information technologies. IT that is able to adjust flexibly to the necessary structural and process changes supports improvement measures. As a result, shortened process times, better quality management and a higher level of satisfaction on the part of patients and employees, plus a secure position in the competition on the health market can be found. The approach developed by IWiG for optimising the process organisation in German hospitals aims at perfectly coordinating the work processes. To achieve this, the Web application ClipMed has been developed, a scientifically evaluated software with the aid of which work processes can be documented, analysed, designed, implemented and evaluated.

## Process optimisation and quality assurance with the aid of IT

ClipMed PPM stands for "Path and Process Cost Manager". This tool is able to depict patient treatment paths in both graphic and tabular form and so document each stage of a patient's hospital stay. Optimisation of the process organisation enables considerable time and cost savings to be achieved without leading to any deterioration in the quality of the patient care. The focus is on process and patient orientation. In collaboration with the company Optiplan, a method has been developed for the production of special medical charts for homogenous groups of patients with specific illnesses.

## Cost transparency

An integral part of ClipMed PPM is the IWiG PRM (Process Reference Model). This includes a "construction kit" which has been devised by IWiG, the modules of which allow the individual treatment processes of a hospital to be combined quickly and uniformly and adjusted as necessary. As a "Process Cost Manager", ClipMed calculates the costs for each service provided in the course of the treatment process, attributing them to the cause, and produces a detailed evaluation report at the press of a button. The cost transparency this generates enables any savings potential that exists to be quickly recognised.



IWiG® 5-phase model  
Phase 1 = Documentation  
Phase 2 = As-is analysis  
Phase 3 = Process design  
Phase 4 = Implementation  
Phase 5 = Evaluation

## Project information//

[www.iwig-institut.de](http://www.iwig-institut.de)

## Contact//

Prof. Dr. Michael Greiling  
IWiG- Institut für Workflow-Management im Gesundheitswesen  
[IWiG Institute for Workflow Management in Health]  
Westfälisches Institut für Gesundheit  
[Westphalian Institute of Health]  
Tel.: +49 209 9596-619  
[michael.greiling@w-hs.de](mailto:michael.greiling@w-hs.de)



# Entrepreneurial Diversity

## Facets of the image of women entrepreneurs in Germany

### Working hypothesis

A hegemonial, one-sidedly male-dominated image of entrepreneurs prevents women from founding or carrying on businesses or taking on employer and executive functions in growing enterprises and thus creating jobs to the same degree as men. The study revealed different self-images that precisely do not correspond to the normal entrepreneurial type.

### Self-image of women entrepreneurs

The project focussed on a question that has hitherto not been systematically investigated, namely the self-image of women entrepreneurs. While the women surveyed wish to be entrepreneurially active, they do not identify with the traditional entrepreneurial type. These self-images, which deviate from the norm of the normal entrepreneur, are also reflected in the aspect of leadership responsibility.

### Step by step

At bottom, the step-by-step type only differs from the normal entrepreneur in respect of the reasons for forming an enterprise and the manner of proceeding, with both of these aspects together resulting in slower growth of the enterprise.

### Crisis

Typical for the crisis type is that he/she is forced by circumstances to take charge of an enterprise and only then engages in entrepreneurial activity. Before the occurrence of the critical event in their lives, they had barely concerned themselves with the challenges associated with embarking on entrepreneurial activity.

### Bricoleur

While bricoleur types also see themselves as entrepreneurial personalities, they act situationally, seeking to create resources out of whatever is available, to make use of them in everyday opportunities and so ensure the survival of the business.

### Entrepreneurial diversity

In view of the factual diversity of entrepreneurship or entrepreneurial activity that can be observed, we plead for the hegemonial entrepreneurial model that has prevailed hitherto to become more fluid. Based on the results obtained from the field of diversity research, therefore, it would also be recommendable to create entrepreneurial diversity. On the other side, however, it would also be important to pay much greater attention than hitherto not only to the results of quantitative research but also - taking these as a basis and adopting a triangulation approach - to apply qualitative methods.

	Normal entrepreneur	Step by step	Crisis	Bricoleur
<b>Reason</b>	Goal/Plan	Developments	Facts	Resources- construction/ Everyday opportunities
<b>Mode of proceeding</b>	Strategic & resource-oriented	Incremental & resource-based	Compelled	Situational
<b>Entrepreneurial goals</b>	Powerful/rapid business expansion	Slow business expansion	Preservation of the business	Survival of the business
<b>Capital resources:</b>				
<b>Economic capital</b>	-/+	-/+	-/+	-/+
<b>Cultural capital</b>	+	+	-/+	-/+
<b>Social capital</b>	+	+	+	-/+
<b>Entrepreneurial personality</b>	+	+/-	-/+	+

Entrepreneurial typology - Draft

### Project information//

Joint project between Dortmund University and the Westphalian University of Applied Sciences. With financial support from the NRW Science Ministry.

### Contact//

Prof. Dr. Katrin Hansen  
Tel.: +49 209 9596-356  
katrin.hansen@w-hs.de

# Telemedicine: Set for the transition from research to broad-based application

In the health economy, there are constant calls for a squaring of the circle: People demand improvements in services, but at the same time more efficient working. One approach to achieving this can be found in modern telemedicine. With the aid of information and communication technology, it is becoming possible to provide timely, patient-oriented care and services for the maintenance and restoration of health even over long distances. In recent years, there has been a wide diversity of research and development activity in Germany in relation to telemedicine. The Institute for Work and Technology („Institut Arbeit und Technik“ (IAT)/Westphalian University of Applied Sciences) has therefore produced an electronic map for Germany in which all projects and service offerings in the field of telemedicine are charted and systematised.



Charting and systematisation of all projects and service offerings in the field of telemedicine:  
[www.iat.eu/ehealth/](http://www.iat.eu/ehealth/)

## Project and service offerings

- Altogether, there are/were around 188 telemedical offerings in Germany with the direct aim of maintaining or restoring the health of patients in their private environment.
- The majority of these are (still) in the area of research, development and testing; only around 30 percent are actually available to patients as concrete, accessible services.
- In a league table of Germany's federal states, North Rhine-Westphalia (NRW) is especially active in relation to telemedicine. 22 percent of all projects and service offerings come from NRW, and a total of 19 services have also found their way to concrete practical application in this region.
- NRW is also home to some ambitious, innovative projects of a kind which have hitherto not been seen elsewhere. One example of this is "teutovital", a project in which rehab patients and health-conscious individuals who undertake walking training in the hilly Teutoburger Wald region are able to have their cardiac status monitored by a special mobile phone that not only transmits ECG data to a heart centre but also summons assistance in the event of a crisis.
- For many years, telemedicine was subject to major difficulties. Since mid-2010, however, optimism has been spreading. There is now an increasing store of data available to back up the effectiveness of telemedicine.

## Application of telemedicine

"In the next few years, telemedicine in Germany has every chance in the world of making the transition from research to broad-based application," says Josef Hilbert, Director of the IAT. "The precondition for this is, though, that the services offered are developed in consultation with the medical and health care professions and that their effectiveness is also proven through clinical trials."

## Project information//

Supported by the Federal Ministry of Education and Research.

[www.iat.eu](http://www.iat.eu)

## Contact//

Prof. Dr. Josef Hilbert  
Institut Arbeit und Technik, IAT  
[Institute for Work and Technology]  
Westfälisches Institut für Gesundheit  
[Westphalian Institute of Health]  
Tel.: +49 209 1707-120  
[hilbert@iat.eu](mailto:hilbert@iat.eu)

# Jatropha nuts

## Energy use of wild plants

From an ecological and energy-management point of view, biomass counts as an attractive resource for use in energy generation. In the Busunu project, jatropha nuts are used as biomass. Jatropha is an oil plant that is inedible for humans and animals, does not occupy land that is suitable for food production and does not displace forest.

The aim is for the available biomass to be utilised as completely as possible. The shells of the jatropha nuts serve as a substitute for firewood. The oil obtained by chopping and pressing the nuts is used as biodiesel. The cake which is left over as waste from the pressing process is used to produce gas in a local biogas plant or as fertiliser. The filter residues from the oil can be processed for making soap.

### Criticism

For both development policy and ecological reasons, the cultivation and utilisation of energy plants is subject to growing criticism. Through the cultivation of energy plants, land available for growing foodstuffs is destroyed. In the project entitled "Regenerative Energy Generation in Busunu, North Ghana", however, that is not the case. The plant is present in many places "in the wild" or is grown in North Ghana on land that is unsuitable for the cultivation of food plants and through the production of this energy plant is therefore ecologically upgraded. Moreover, the investment needed for the production of biodiesel from jatropha is considerably lower than for other biofuels.

### Development of production structures

The principal purpose of the project is to further develop and generalise the technical production structures and so make the project transferrable. The aim of the project was to test the technical requirements for jatropha processing and develop an initial approach towards a model for generating sustainable income structures for the local population with minimum financial input. The necessary technical process steps for producing the vegetable oil were tested in advance in the Mechanical Process Technology Laboratory at the Westphalian University of Applied Sciences. Kumasi University in Ghana supplied the know-how for the chemical/physical processing of the vegetable oil. Initial rudimentary trials were conducted on the ground in Ghana.



The University of Kumasi in Ghana provided the know-how of the chemical-physical processing of vegetable oil. First rudimentary experiments were then performed locally in Ghana.

### Power supply

Over 60 houses as well as the infirmary, schools and the church were already connected up to the village electricity supply system by the end of 2007. 24-hour power supply is ensured partly by the vegetable oil generator and partly by a hybrid installation with solar modules.

### Future prospects

Due to their remote location, countless villages throughout the world, but especially in Africa, cannot be connected up to the public electricity grid. As a result, young people migrate from the rural areas, hoping to find a better life in the towns/cities and conurbations. A regional power supply structure based on energy plants would help to combat this and also bring jobs and money to remote regions.

### Contact//

Prof. Dr. Ralf Holzhauer  
Westfälisches Energieinstitut  
[Westphalian Energy Institute]  
Tel.: +49 209 9596-163  
ralf.holzhauer@w-hs.de

Prof. Dr. Alfons Rinschede  
Westfälisches Energieinstitut  
[Westphalian Energy Institute]  
Tel.: +49 209 9596-180  
alfons.rinschede@w-hs.de

# IHMoS

## Intelligent Hand Hygiene Monitoring System

Careful disinfection of the hands is the most effective weapon of all against hospital infections. It can significantly reduce the number of dangerous infections and is also an inexpensive and simple method for combatting infections.

### Wireless technology

Under the leadership of Prof. Dr. Udo Jorczyk, researchers in the special "Physical Technology" group have developed a monitoring system for hand disinfectant dispensers. The dispensers are equipped with state-of-the-art wireless technology. These integrated transmitter devices send the data to a receiver. Experience has shown that because of the high radio signal range, only one such receiver is needed for an entire ward. The receiver gathers the data from the dispensers and passes it on via WiFi or ethernet to a central evaluation computer or to the hospital information system. The evaluation system enables the continuous automated collection of data on the level of disinfectant consumption at the disinfectant dispensers linked into the system.

### Individual evaluation

Depending on the type of dispenser, either batteries are used or the dispenser has its own self-sufficient power supply. Old dispensers can usually be retrofitted with a transmitter unit. Each time a dispenser is operated, the date and time of operation and the identification number previously allocated to the dispenser are transmitted. Evaluation can be carried out as individually specified. It is possible for the use of individual dispensers, a group of dispensers or all of the dispensers to be evaluated. Use of the dispensers in individually definable time periods can also be evaluated. The data allows inferences to be drawn concerning the local use of disinfectant and the time of use, and also the causes of infection to be investigated and eliminated.

### Statistics for local or central assessment

On the basis of the data from these user logs, it is possible to produce statistics that provide a holistic view of hand hygiene quality. Through the anonymous data collection, the whole nursing team is viewed as a unit. Evaluation of the statistics allows conclusions to be drawn about the level of compliance, surveys to be conducted concerning appropriate dispenser positioning, and analysis of the causes of infection or evaluation of the rate of disinfectant consumption in relation to certain parameters to be carried out. The system also helps to save costs, and ultimately constitutes a competitive advantage for the hospital. By linking-up the databases between various hospitals, it is additionally possible to perform central assessment and individual evaluation. Taking into account the hospitals' own indicators, therefore, the opportunity therefore exists to compare different hospitals and improve objectivity in relation to the issue of certificates, quality seals, etc.



IHMoS network structure with dispensers, IHMoS receiver, server and workplace PCs

**Project information//**  
[www.ihmos.de](http://www.ihmos.de)

**Contact//**  
Prof. Dr. Udo Jorczyk  
Tel.: +49 209 9596-584  
[udo.jorczyk@w-hs.de](mailto:udo.jorczyk@w-hs.de)



# CityGML-Toolchain

## Development and application scenarios for 3D urban models

Increasing numbers of local authorities are in possession of large virtual 3D models of their towns or cities which they use for their internal administration purposes or would like to present to the public through the Internet without publishing them on Google Earth. However, publication of these models is complicated, and not just because of the large volume of data. The aim is that the data should also be available to all workplaces with access to geodata, that the handling should be simple and that the loading times should be as short as possible.

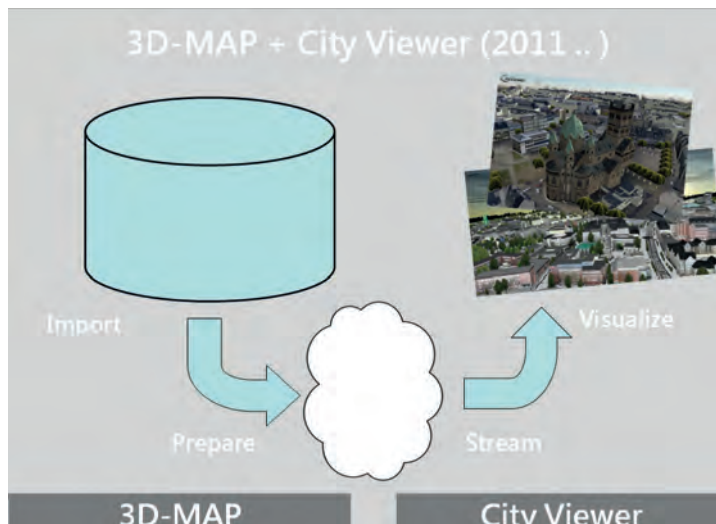

Performant visualisation of large virtual 3D urban models

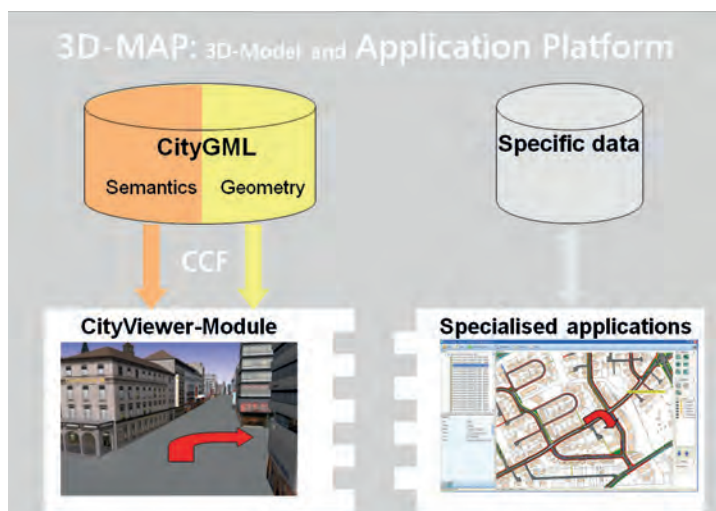

3D Map and City-Viewer

Performant visualisation of large 3D urban models on stationary (and mobile) terminal devices for integration into specialised applications with large 3D urban models.

### Performant visualisation

The “CityGML-Toolchain” project involved the development of performant visualisation of large, virtual 3D urban models on the Internet. From there, they can be visualised on both stationary and mobile terminal devices and so integrated into specialised 3D applications. The platform and viewer form an open system: The developers of specialised applications on 3D urban models need have no expert knowledge of graphic programming if they wish to equip their application with visualisation. It is also possible, via a software interface, to access the model data from the viewer; there is, therefore, need for the developers to also look after provision of the model data.

### Streaming

In a final processing step, the use of a special streaming format makes it possible for the models to be transmitted efficiently via the Intranet or Internet in real time. The format encompasses both the geometric and semantic data of the original model. If required, these can be encrypted to prevent access to the original data.

### Application

Visualisation is possible on both stationary and mobile terminal devices. Integration into web applications, special processing for stereoscopic viewing and synchronised navigation through an urban model are all possible thanks to different variants of the view mode.

Applications for the 3D models exist in a number of areas:

- Tourism/city marketing
- Architecture (Presentation of building projects which are planned in the urban environment)
- Public participation (involvement of the public in planned building projects)
- Solar potential analyses
- Navigation (e.g. as an aid to orientation in mobile data collection)
- Disaster management (coordination of emergency services, marking of hazard sites)

### Project information//

A large part of the project results originated from the IKT.NRW project GIFMe, which was conducted from 2009–2011 with financial support from the EU. [www.citygml.de](http://www.citygml.de)

### Contact//

Prof. Dr. Gerhard Juen  
Tel.: +49 2871 2155-830  
[gerhard.juen@w-hs.de](mailto:gerhard.juen@w-hs.de)

Prof. Dr. Ulrich Kaiser  
Tel.: +49 2871 2155-818  
[ulrich.kaiser@w-hs.de](mailto:ulrich.kaiser@w-hs.de)

# Service quality in mode choice modelling for regional transport

The aim of the study was to determine influences of service quality on mode choice between a regional train and a regional bus and to determine the trade-off between quality and fare by calculating the willingness to pay for changes of service quality. Due to respondents' information overload, common stated choice analysis only allows for a rather restricted number of attributes to be analysed. To overcome this problem the method of "Integrated Hierarchical Information Integration" was applied.

## Method used

The method used in this study was based on the idea that similar attributes describing service quality can be summarised and replaced by constructs. In this study eleven service quality attributes were analysed and summarised by the constructs "Quality of Connection", "Comfort", and "Information". 2000 interviews were conducted with train riders. Respondents were first familiarised with the attributes and the constructs. Subsequently, in integrated choice experiments, they chose between a hypothetical regional train and a hypothetical regional bus which were characterised by varying levels of fare, total travel time, the attributes of one construct and summarising construct values of the remaining two constructs. A car option was only presented to respondents having a car available (non-captive riders).

Choice experiment

## Choice experiments

As there were three constructs there were three different choice experiments, each exchanging a different construct by its corresponding attributes. The exchange of a construct and its corresponding attributes should not affect the estimation of the other parameters. Hence, it was possible to test if the constructs summarise the attributes adequately. Respondents were randomly assigned to one of three corresponding groups. A Multinomial Logit Model was estimated for every group. The probability P that the train was chosen was described as:

$$P_{Train} = \frac{e^{\mu(X_{Train}\beta + G_{Train}\gamma)}}{e^{\mu(X_{Train}\beta + G_{Train}\gamma)} + e^{\mu(X_{Bus}\beta + G_{Bus}\gamma)} + e^{\mu(X_{Car}\beta)}}$$

where X and G were the vectors of attribute and construct levels,  $\beta$  and  $\gamma$  the vectors of estimated utility coefficients of the attributes and constructs, and  $\mu$  a scaling parameter. A two-stage likelihood ratio test was applied.

## Outlook

Results for the captive riders show equality of the construct parameters as well as the scaling parameters. That means data could be pooled into a concatenated model with all service attributes. Willingness to pay for changes of service quality was then calculated. For the non-captive riders, equality of construct parameters was shown but not for the scaling parameters. For further results see: Richter, C., Keuchel, St. (2011), Modelling Mode Choice in Passenger Transport with Integrated Hierarchical Information Integration, in: Journal of Choice Modelling.

## Project information//

This work was financed by the FHprofUnd programme of the German Federal Ministry of Education and Research and supported by three local transport companies in the Westphalia area.

## Contact//

Prof. Dr. Stephan Keuchel  
 Institut für Mobilität und Verkehr "MoVe"  
 [Institute for Mobility and Transport "Move"]  
 Tel.: +49 2361 915-428  
 stephan.keuchel@w-hs.de

# Nanoparticle-based solvent-free polymer reactive dispersions

Solvent-free polymer reactive dispersions can be produced using nanotechnology. The polyurethanes are present as reactive diluents in an acrylate, and in an initial poly reaction, polymer nanoparticles are created through a patented in-situ polymer synthesis process. The resulting dispersion is of low viscosity. After processing, even in adhesives or paint formulations, products with excellent properties are created which can be individually tailored to meet specific requirements. With the patented technology it is possible, for example, to manufacture products or additives with outstanding tensile shear strength or mechanical strength.

## Properties

The dispersions are solvent-free with a solid PUR content of up to 60% and a PUR particle size of < 100 nm. The dispersions, which have an extremely long storage life, are suitable for use not only as adhesives but also as impact modifiers that can be optimally adjusted to the respective base polymer and hence to the object to be glued. The adhesive retains its transparency after hardening, and even after a period of many months shows no signs of yellowing. Up to 50% acrylate can be added to the dispersions without resulting in any turbidity after hardening.

## Applications

Possible applications of the polymerisable polymer dispersion includes uses in wood and car paints and in protective coatings for building structures, as adhesives for metal, wood and glass, for resin castings and laminated glass, as well as for films and coatings. It is possible to make products or additives that achieve very high, flexibly adjustable tensile shear strengths, e.g. in adhesive formulations. Moreover, the dispersion is transparent as the diameter of the nanoparticles is smaller than the wavelength of light. Therefore, an adhesive with the new additive is ideal for gluing "phono" furniture or attaching fittings to glass doors. Adhesives for vehicle body panels or car windows must have high impact resistance and elasticity in order to absorb shocks from the road. The patented polymer dispersion combines these properties as an adhesive by causing the nanoparticles to float like buffers between the molecules of the base adhesive mass.

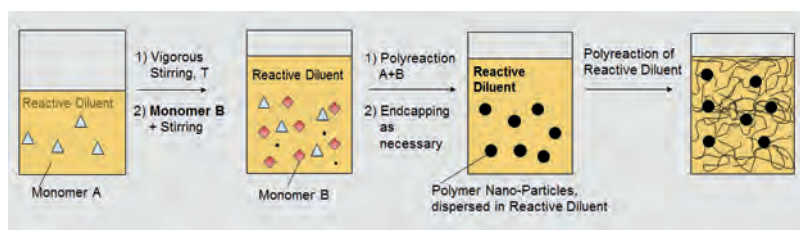

The polymer nanoparticles are present in an acrylate as a reactive diluent. They are created through a patented in-situ polymer synthesis process, and it is this that produces the special properties.

## Product features and user benefits:

- Solvent-free dispersion of PUR nanoparticle in (Meth-)Acrylates as reactive diluents
- Solid PUR content of up to 60%
- PUR particle size of < 100 nm
- A possible application as adhesives, resin castings, films, coatings, paints etc.
- Very high tensile shear strength
- Very high notch impact strength; up to 16x compared to a reference
- Fracture strain up to 350%
- Very high transparency
- Excellent weathering and UV resistance
- Suitable for UV-, redox- and also thermo-setting systems
- Months of storage stability of the dispersions before polymerization
- Other polymer-monomer-substance classes possible
- The development and manufacture of products or additives for custom applications is possible

## Project information//

Patent number EP 1910436 B1, Application: 14 July 2006, Granted: 28 January 2009

Know-how on individually developed applications available.

Patent owner: Dritte Patentportfolio-Beteiligungsgesellschaft mbH & Co. KG

## Contact//

Prof. Dr. Klaus-Uwe Koch

Tel.: +49 2361 915-456

klaus-uwe.koch@w-hs.de

# An educational jungle in NRW between school, vocational training and work

## Programmes, educational courses and other measures in the transition system

The structures, processes and actors in the transitional system between “school - vocational training - work” in the state of North Rhine-Westphalia (NRW) have become well-nigh impenetrable. In particular, the plethora of programmes, measures and educational courses offered at the various levels – local authority, state of NRW, national level – are not coordinated in any way whatsoever, with the result that the constellations of actors, the participant numbers and the volume and effectiveness of the resources invested are largely surrounded by darkness.

### Transitional measures

A total of 126 initiatives, programmes, educational courses and other measures were found to have been offered in North Rhine-Westphalia in the year 2010 by the central government, the state of NRW and the Federal Employment Agency (Bundesagentur für Arbeit). According to estimates by IAT researchers, the number of people involved in the transitional system in NRW in 2009 (i.e. counting transitional education/training courses, programmes offered by the Federal Employment Agency and repeat job applicants) amounted to some 140,000 to 150,000 participants. That was more than twice the number of new additions to the transitional system in the same year, who totalled 71,418 people. “Even two years after joining a transitional programme, one third of them, i.e. nearly 50,000 young people, have no chance in North Rhine-Westphalia of receiving qualified vocational training,” the IAT education researchers criticise. “Many of them get nowhere, and no one knows why!”

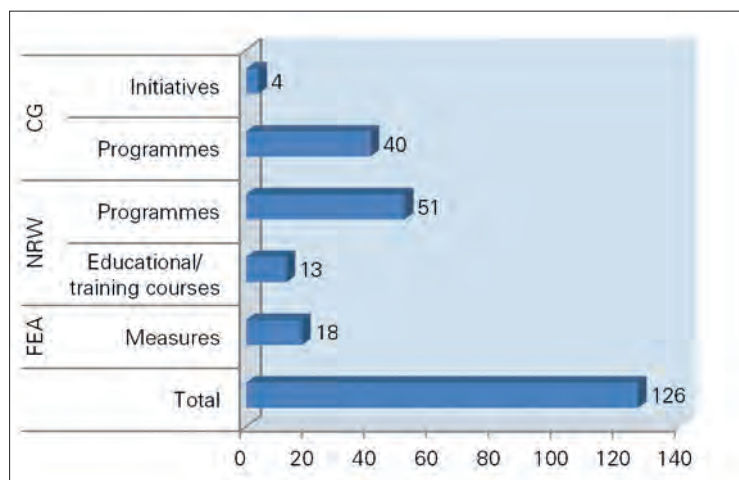

Initiatives, programmes and educational/training courses in NRW (preliminary study page 48)  
CG (Central Government), NRW (North Rhine-Westphalia), FEA (Federal Employment Agency)

### Financial structures

Concerning the financial structures for the transitional system, the study comes to the conclusion that in 2009, funding resources were mobilized in NRW from the NRW state government, the federal government and the Federal Employment Agency worth an estimated €800 million, with NRW by itself contributing some €440 million from its own resources (vocational colleges and financial support). In the field of “Actors and controlling instruments” the status of information and data is, as the IAT researchers found, close to zero. There are, for example, no verifiable facts available regarding the number of people working in the transitional system or their professional qualifications. Even among vocational training experts, the estimates range from 30,000 to 100,000 personnel nationwide. “Given the number of young people concerned and the volume of public financial resources involved, this is a situation that can no longer be tolerated. Otherwise, all efforts to make the transitional system in Germany more efficient will be doomed to failure before they have even started.”

The IAT researchers see improving efficiency as essential, because to achieve better vocational integration of many young people in the current transitional system, even higher spending will presumably be needed for the time being, which can be expected to push any cost savings arising from demographic changes far into the future. Moreover, the costs of providing vocational skilling for older applicants who, despite wanting to enter vocational training were unable to enrol on a programme leading to a vocational qualification, should also not be underestimated.

### Project information//

[www.iat.eu](http://www.iat.eu)

### Contact//

Dr. Michael Krüger-Charlé  
Institut Arbeit und Technik, IAT  
[Institute für Work and Technology]  
Tel.: +49 209 1707-122  
[kruegerc@iat.eu](mailto:kruegerc@iat.eu)



# AdMotional

## Better online advertisements through personalised banners

Many online users are annoyed by ads that lack personal relevance. Consequently they ignore them. The AdMotional project investigates how a win-win situation can be achieved for online advertisers and web users alike, through optimisation of the campaign selection process and the creation of individually personalised ads. The project focuses on three aspects: first on the initial targeting process, second on the run-time personalisation of ad media design, and third on automatic improvements through a self-learning optimisation component.

### Method

AdMotional combines and enhances state-of-the-art targeting technologies by using a novel concept of emotional targeting that allows for campaign selections based on consumer moods. This step is further extended by moving from the traditional (campaign-based) targeting to an additional more fine-grained ad-based targeting – aiming for the single, best-matching advertisement. After selection, specific customization points are identified as the basis for individual customization of the ad media, resulting in a personalised ad. Ad personalization furthermore demands the dynamic creation of the ad itself, for which different approaches have been evaluated using templates and an XML-based banner design language.

A typical scenario for the use of AdMotional (figure): Imagine, a web user who spends some time visiting various dating sites (1 to 3), then moves to an online music store (4) and checks out the track list of the latest CD of his favourite artist (5). While traditional behaviour targeting would lead to an ad being displayed either tailored to the sociodemographic or interests profile, emotional targeting also tries to take into account the user's emotional situation. As he spends quite some time on dating sites, he may be emotionally involved in some joyful communication. Combining this with results e.g. from behaviour and geo targeting (user's location) will lead to an individually (but automatically) designed advertisement, for instance offering tickets for a concert coming soon in a nearby arena using a romantic background and a text message tailored to the user's age and gender, such as "Get the last tickets and bring your girl to...", or a more serious version for the senior audience.



5 stations to produce advertising material on your smartphone

### Results and perspectives

Finally, the system's self-learning feedback component complements the overall system by constantly monitoring and analysing ad performances in an attempt to derive rules not only for optimising the targeting and personalisation processes, but also to inform ad designers of the most influential factors to be considered. On a more technical level, inductive learning will inform ad designers about most influential factors, e.g. changing colour schemes, typography, or layout aspects.

The main results of the project have been published in the following journal paper: M. Meyer, M. Balsam, A. O'Keefe, C. Schlüter: AdMotional: Towards Personalized Online Ads. Intern. Journal of Computer Science and Applications (IJCSA), Vol. 8, No. 2, pp. 59 – 80, 2011.

### List of Participants

- Westfälische Hochschule – University of Applied Sciences  
Dept. of Mechanical Engineering, Bocholt (project coordinator)  
Dept. of Electrical Engineering, Bocholt  
Institute of Journalism and Public Relations, Gelsenkirchen
- Life and Brain GmbH, Bonn
- The AdInsider GmbH, Bocholt

### Perspectives, Approaches and Ideas for Further Development at the EU Level

Perspectives for ongoing efforts also include the evaluation and finetuning of the feedback-based ad optimisation techniques in longterm real-life tests. The AdMotional system with its fine-grained contextual analysis can also be used for retargeting due to its general and flexible architecture, for brand protection by avoiding misplacements of ads in a probably brand-damaging environment, or for early identification of sentiments shifts to avoid brand damage or to act on the stock market.

### Project information//

Funding: State of North-Rhine Westphalia and European Union within the ZIEL2 programme 2007-2013 (EFRE), IKT.NRW (FKZ 29 00 341 02).

### Contact//

Prof. Dr. Manfred Meyer  
Tel.: +49 2871 2155-910  
manfred.meyer@w-hs.de

# Individual anatomical implantation of shoulder endoprotheses through ultrasound volumetric imaging-based pre-operative planning and intra-operative navigation

Within the scope of the project, the navigated implantation of a humeral head prosthesis was performed on the basis of ultrasound imaging was conducted. The implantation, including the correction of deformation of the joint, was performed without the application of any other volumetric imaging methods such as computer tomography (CT) or magnetic resonance tomography (MRT), using only appropriately processed ultrasound imaging volumes.

## Humerus coordinate system

A definition has been proposed by the International Society of Biomechanics, defining the origin and axes of a local humerus coordinate system. Based on this definition, a scanning protocol for ultrasound imaging volumes was defined. In compliance with this protocol, ultrasound imaging volumes of the humerus were acquired using a newly developed data recording software system. The ultrasound images were obtained using a tracked 2D hand-held probe.

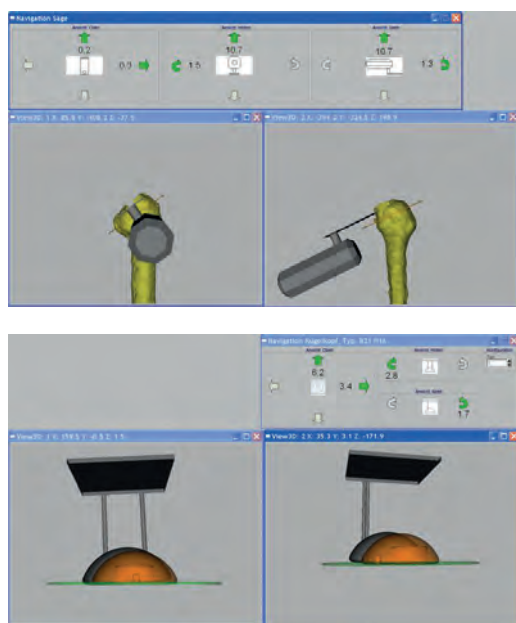

Draft of a navigation surface for performance of the intervention based on parameters obtained from the ultrasound imaging volumes, namely (a) navigation of the oscillating saw for resection of the humerus head, and (b) navigation of the head prosthesis for anatomically correct restoration of the centre of rotation of the shoulder joint

## Visual verification and segmentation

For visual verification of the ultrasound volumes and segmentation results, a graphic user interface was implemented. The result of the segmentation process were points on the surface of the bone which were used to model a virtual bone surface. In a study using animal specimens, the geometrical accuracy of the computed virtual bone surface was determined (more than 95% of all points < 0.5 mm). For planning the surgery, landmarks were interactively positioned on the virtual bone surface, and the humerus coordinate system resulting from this was superimposed. The position of the prosthesis was also defined interactively, based on the virtual bone surface. The ultrasound volumetric imaging-based preoperative planning and intraoperative navigation was performed by way of demonstration on three human anatomical specimens for a third-generation prosthesis.

## Limitations regarding prosthesis implants

In the course of the study it was found that the implantation of third-generation prosthesis is subject to two main limitations. First, inclination and retrotorsion of the head can only be achieved by exact planning and positioning of the shaft of the prosthesis as the head component does not allow any correction of these parameters. And second, the extremely firm cortex of the shaft of the humerus limits the handling of the implantation instruments or determines their positioning in the bone.

## Feasibility of implantation

In the course of the project, a study was conducted involving the performance of 3D ultrasound imaging on 21 humerus specimens. In a study performed on five test persons, 20 volumetric scans of the humerus were produced and the general feasibility of planning and implantation of a humerus head prosthesis based on ultrasound volumetric data obtained by freehand scanning was demonstrated.

## Project information//

Supported by funding from the DFG Priority Programme 1124 "Medical Robotics and Navigation".

## Contact//

Prof. Dr. Heinrich Martin Overhoff  
Westfälisches Institut für Gesundheit  
[Westphalian Institute of Health]  
Tel.: +49 209 9596-582  
heinrich-martin.overhoff@w-hs.de

# Botnets

## One of the greatest dangers on the internet

Botnets are currently considered as one of the greatest dangers on the Internet. Bots are illegally hijacked, remotely controlled computers on which various applications can be run in the background. In the past it was possible to observe botnets with up to six digit numbers of bots all around the world. But a definite trend towards multiple smaller botnets has evolved. Since these are controlled centrally, the potential risk, however, is just as great.

Among the frequently occurring threats from botnets are spam campaigns, distributed denial-of-service attacks, identity theft and theft of other data, as well as the infection of other computers with malware. The aggression potential of botnets is enormous. A computer can be infected through visiting specially prepared web pages, through dissemination by infected emails or through the use of applications with security weaknesses.

### Communication architectures

For coordination and communication purposes, generally referred to as command and control (C&C), botnet operators usually use two kinds of communication architecture. On the one hand, commands may be issued through a central server. Under certain conditions, this kind of C&C architecture can be detected. But on the other hand, there are botnet C&C architectures with a decentralized structure, e.g. using peer-to-peer protocols (P2P). This kind of architecture is much more difficult to detect. In future, even hybrid architectures are conceivable, linking P2P networks via a central server.

### Analysis and detection of botnets

The Institute for Internet Security is engaged in the development of ideas and methods for the analysis and network based detection of botnets. Honeypots are used for the acquisition of malware; which is then executed in a sandnet, i.e. a controlled environment. To analyze them properly, however, bots have to be allowed to run in an environment that is as real as possible, with no major intervention in the communication. On the other hand, potential harm can only be prevented through intervention. The Institute for Internet Security resolves this conflict by redirecting harmful Internet traffic such as spam to its own servers – but without this being detected by the malware. As a result, the original target of the Internet attack is protected. Recording the network traffic can also serve as means of detailed analysis and enable researchers to develop networkbased signatures for recognition of this malware.

### Botnets in mixed data traffic

A further area of research is the recognition of botnets in mixed data traffic, particularly in highspeed networks. Botnet detection could therefore take place at Internet exchanges, e.g. DE-CIX, one of the biggest Internet exchange points in Europe. Finally the theoretically tested approaches are then evaluated in real-life networks.

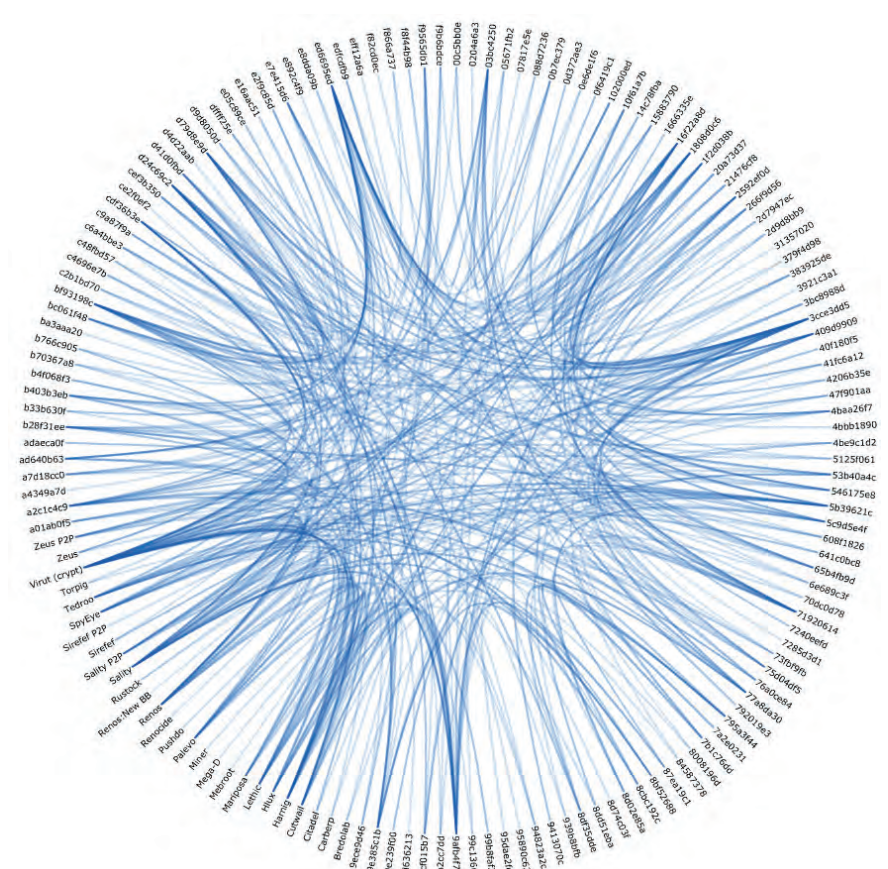

Decentralized botnets cause infected computers to form highly distributed structures.

### Project information//

Assisted by the EUROPEAN UNION, European Fund for Regional Development Investment in our Future. [www.internet-sicherheit.de](http://www.internet-sicherheit.de)

### Contact//

Prof. Dr. Norbert Pohlmann  
Institut für Internetsicherheit  
[Institute for Internet Security]  
Tel.: +49 209 9596-515  
[norbert.pohlmann@w-hs.de](mailto:norbert.pohlmann@w-hs.de)



# Reduction in particulate emissions from small-scale combustion plants using conventional and electrostatically charged scrubbers

Within the scope of a research project into the "Reduction of particulate emissions from small-scale combustion plants", the level of particulate collection by conventional scrubbers on the one hand and, on the other, scrubbers with additional electrostatic charging of either the particulates or the scrubber field or both, was measured and compared. At the same time, the effects of operating parameters such as nozzle type and pressure and the number and mode of operation of the scrubber fields for different qualities of combustion in operation with both wood and straw pellets was also investigated.

## Influencing factors

The results show a significant influence of nozzle pressure and the number of conventional scrubber fields on the collection performance – regardless of whether operating in concurrent flow or counterflow mode.

## Conventional scrubbers

Through their mode of operation, conventional scrubbers are virtually unable to collect particulates with an aerodynamic diameter of  $d < 1 \mu\text{m}$  as such extremely fine particles follow the gaseous fluid flow. The results demonstrate, however, that because of the increase in the mass of the collectable particles with  $d > 1 \mu\text{m}$  - which rises with the third power of the diameter  $d$  - overall collection performances of around 50% are nevertheless achieved.

## Additional electrostatic charge

Where there is an additional electrostatic charge, either the particles and/or the scrubber field are charged. Investigations were conducted with charging of the water only, charging of the particulates upstream of the scrubber, and a combination of water charging and particulate charging with different voltages and nozzle pressures at the scrubber field. The combined charging of particulates and scrubber field, with a virtually identical charge for both water and particulates, was found to be the most effective arrangement, with a 71% collection rate.

## High collection performance

However, the highest collection performance, with a particulate reduction of 86%, was achieved with charging of the particulates only, ahead of conventionally operated scrubbers, as it was possible to raise the voltage to as high as 25 kV. Also with poor combustion quality, the high collection performance was still maintained. The scrubber function is not dependent on the level of the particulate content.

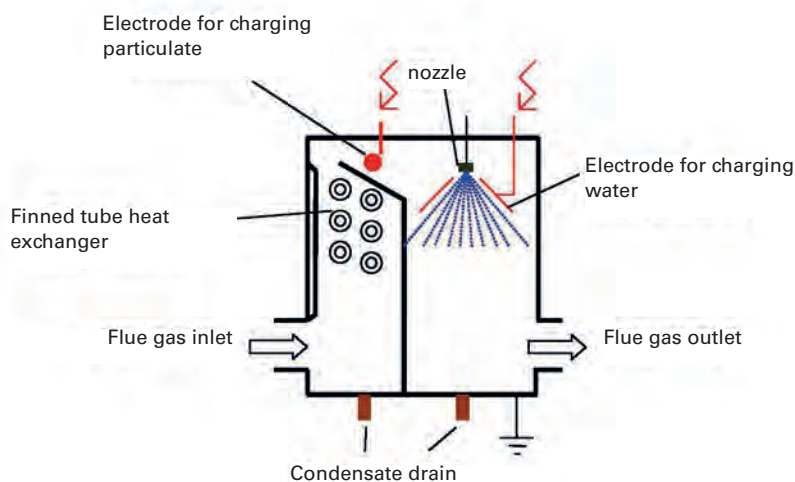

Schematic depiction of electrostatic charging either of the particles or the scrubber fields in the flue gas scrubber or both

## Project information//

Project assisted by BMELV/FNR.

## Contact//

Prof. Dr. Rudolf Rawe  
Tel.: +49 209 9596-306  
rudolf.rawe@w-hs.de

Dipl.-Ing. Hermann Kuhrmann  
Tel.: +49 209 9596-307  
hermann.kuhrmann@w-hs.de



# Innovation strategies in the construction industry - An international comparison

Innovations in the construction industry can only be understood if not just the core area is considered, but the value chain as a whole, and it was the latter that formed the starting point for the investigations within the framework of the research project on "Innovation strategies in the construction industry - An international comparison". The innovation activity within the value chain in 16 European countries was compared with the aim of systematically identifying the position of the construction industry in Germany and identifying benchmarks in the shape of examples of good practice.

## Positioning compared to other European countries

A comparison of the data shows that the technical innovativeness of the value chain - measured by the number of patents - can be clearly seen. On this count, with 42 percent of all technical patent applications in the field of building and construction, Germany is the clear leader among the EU 15 countries under comparison. Germany is also in the leading group in terms of the promotion of energy-efficient construction and in efficiency indicators relating to the building process. A further strength of the German construction industry value chain can be seen in the above-average share of industrial suppliers. As far as productivity is concerned, German is a midfield player. Other features are the above-average depth of production and the likewise above-average number of architects and the below-average significance of the construction industry for the economy as a whole. Challenges for the construction industry value chain are the only moderate to low level of network activity and the level of further training activities, which is below the European average. The platforms for communication and the diffusion of innovations also tend to be more localised and less exposed than in the most advanced countries in this regard.

## National structures and innovative impulses

Despite the trend towards a Single European Market with uniform standards, the building industry still tends to follow specific national innovation paths and to have differing regulations-factors which, except in the case of major projects in the field of infrastructure and industrial construction, continue to place tight limits on internationalisation. The innovation potential of regulations can be seen most clearly in the field of energy efficiency.

## Development potential and benchmarks

The key question for the further development of the construction industry value chain remains that of process optimisation and - associated with that - new business models. In this context, the skills of the workforce and their ability to collaborate across the boundaries of professional skills and work groups and to use the new possibilities offered by IT for coordination and documentation of the processes play a central role. Bottlenecks can be observed in all countries regarding the diffusion of innovations. In this area, European benchmarks such as the communication platform offered by the research and innovation cafés in Switzerland or the benchmark systems in the UK and Denmark can provide impulses for the further development of the innovation system in Germany. However, the models cannot be transferred one-to-one and successful implementation will depend on the fulfilment of specific requirements such as the call for transparency on the part of private customers, supplemented by incentives of the the public sector.

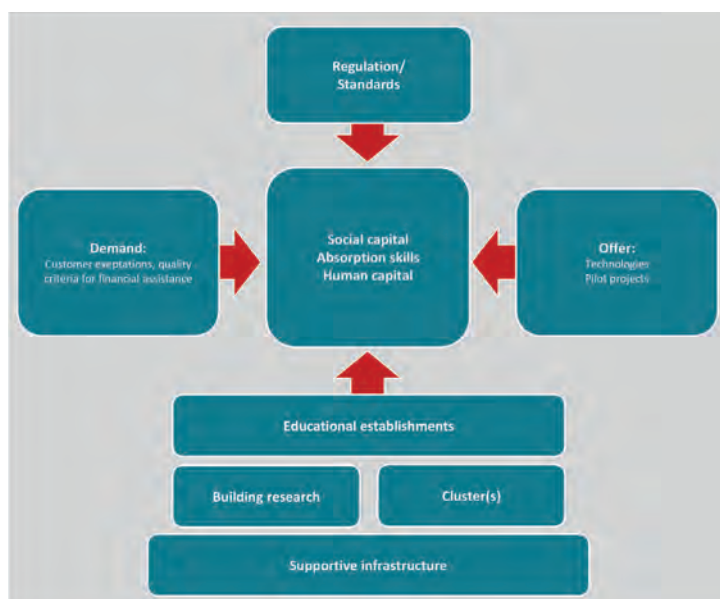

Simplified context of innovations in the European construction industry

## Project information//

Institute for Work and Technology (Institut Arbeit und Technik - IAT), Gelsenkirchen  
 Federal Institute for Building, Urban and Regional Research (BBSR), Bonn.  
 Federal Ministry of Transport, Construction and Urban Development (BMVBS), Berlin.  
[www.iat.eu](http://www.iat.eu)

## Contact//

PD Dr. Dieter Rehfeld  
 Institut Arbeit und Technik, IAT  
 [Institute for Work and Technology]  
 Tel.: +49 209 1707-268  
[rehfeld@iat.eu](mailto:rehfeld@iat.eu)

# Reporting on robot innovations and autonomous systems

The Robotics Laboratory of the Westphalian University of Applied Sciences is engaged in the development of autonomous robots, using technologies and making them out of materials that are already available on the market as mass-produced, low-cost products.

## Present everywhere

All you need is an off-the-shelf mini-robot, a laptop, a camera and a Smartphone app or plug-in for Skype and you can be present everywhere, without actually being there on the ground. On top of the basic mobile robot is also a Smartphone or laptop and an adjustable camera. With the aid of the program, the robot can be monitored and remote controlled. Via a monitor, the tele-user can see through the camera eye of the robot and control the speed, direction and line of sight of the robot, using nothing more than the computer mouse. With the aid of an additional laser scanner, the mini-robot can also scan its surroundings and generate three-dimension plans and maps - a capability of special interest to architects and future house owners.

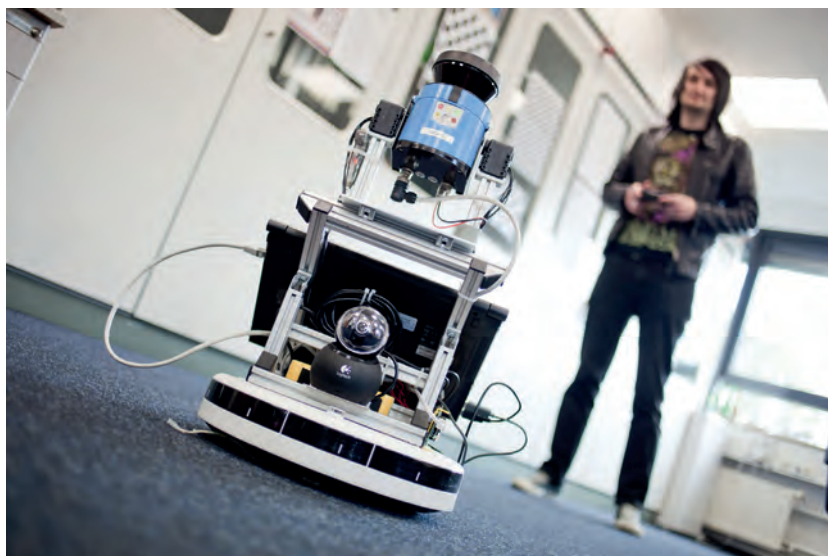

Remote-controlled telepresence robot



Indoor orientation through text recognition processes

## Orientation indoors

Outdoors, robots find their way about with the aid of satellite navigation (GPS). In enclosed spaces, a robot first has to generate its own system of points of reference, unless it uses one already used by humans, namely in the form of signs. This problem of localisation that besets mobile robots has been solved through a combination of text recognition processes, a programmable, high-resolution digital camera and specially developed software. By scanning its surroundings, the reading robot creates a virtual three-dimensional robot world and is therefore able to move about indoors autonomously and with no need for remote control.

## Speedy programming of industrial robots

Programming industrial robots is a highly complex and costly business, making the deployment of such helpers only worthwhile for the production of very large quantities of items on an industrial scale. However, in the world of computer games, players are already able to control the movement of the characters simply through their own body movements. This is made possible by the sensor technology to be found in game consoles, which are now a mass product. The 3D sensor supplies the three-dimensional information as an image and also in the form of spatial depth. With this data and appropriate programming, industrial robots are now being controlled in the Robotics Laboratory of the Westphalian University of Applied Sciences. This means that today, even small and medium-sized firms are able to "train" industrial robots and use them in their production processes.

## Drones - the helpers of the future

Sadly, crisis and emergency situations are a regular occurrence. In the EU projects NiFTi and Tradr, we, together with other partners from the EU, are engaged in the development of drones that are designed to support fire brigades in their missions. One drone that has been developed within the framework of the project already survived its ordeal by fire in July 2012 in the earthquake in northern Italy.

## Project information//

<http://homepage.informatik.w-hs.de/HSurmann/>  
Videos of the projects can be view on the Robics Laboratory's own channel:  
<http://www.youtube.com/RoblabFhGe>

## Contact//

Prof. Dr. Hartmut Surmann  
Tel.: +49 209 9596-777  
[hartmut.surmann@w-hs.de](mailto:hartmut.surmann@w-hs.de)

# ELMO<sup>S</sup> – Electromobility solutions for cities and regions

Heavy traffic volumes, congested streets and roads and traffic-based emissions represent a growing problem for many towns, cities and regions. Electric mobility is one potential approach to dealing with this problem but is currently dogged by severe fragmentation of research activities, a lack of common standards and a high level of investment risks for towns, cities and regions. Additionally, the absence of change in people’s mobility behaviour and the development of user-oriented intermodal mobility solutions are unsatisfactory. In this context, relief is promised in the shape of holistic green mobility solutions that are embedded in the respective regional and urban structures.

New intelligent specialisation strategies and the expansion of regional skills, plus the early involvement of the actors are absolute essentials. Additionally, it is necessary to create transparency across urban and regional boundaries and to pool resources in order to establish sustainable mobility solutions over a broad area.

Against the background of these issues, ten partners, including six clusters in the automotive, information and communication technology (ICT) and green energy sectors, have joined forces. Within the framework of ELMO<sup>S</sup>, an FP7 project, they are devoting their attention to three cross-cutting topics in particular:

## Innovative business models

These are being developed to include the transition from “mobility products” to “mobility services” and also the growing number of alternative propulsion systems. These include, for instance, interdisciplinary solutions that link up intelligent digital networks, network solutions as well as adequate recharging infrastructures in towns, cities and regions. The increasing integration of the automotive, green energy and ICT sectors to form a single value creation system is as central to this as is the inclusion of the users in the problem-solving process. As a result, there is growing importance for electromobility platforms that combine billing and roaming models with individual customer needs.

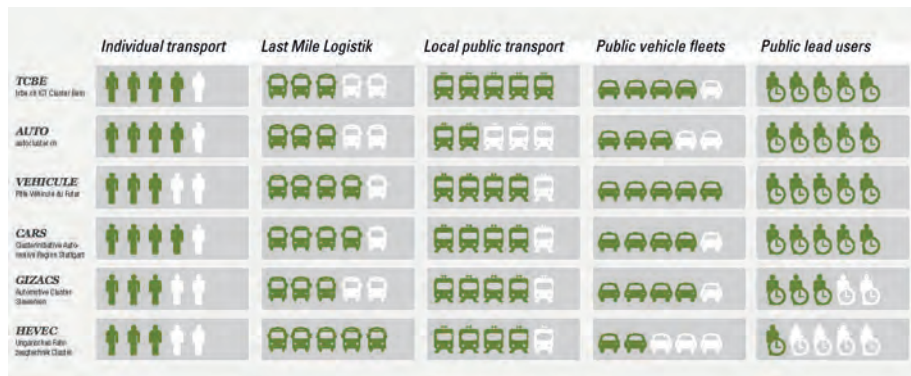

## Perception of the relevance of electromobility

An initial survey conducted in the regions involved showed that the relevance of electromobility and associated solutions within the clusters is perceived very heterogeneously. Especially the established automobile clusters show high figures in this regard. The significance of the various electromobility-related user groups in the regions is varying assessed.

## Cross-sector innovations

The precondition for cost-effective market launch are integrated processes, ICT solutions and standards that ensure the availability of easy and problem-free access for the customers to recharging infrastructures and corresponding services within Europe. With preference being given to an interdisciplinary approach, possibilities for cross-sectoral innovations are being developed with the aim of driving forward the optimisation of collaboration in the field of sustainable mobility.

## Holistic mobility concepts

These take account of various transport modes, new utilisation concepts and intelligent logistics. Changes in mobility and infrastructure usage of this kind call for management and control of private and public transport with the aid of intelligent ICT systems. Passenger transport in particular offers many possibilities for optimisation. The basis for this - alongside the analysis and identification of utilisation behaviour and mobility needs - is the development of sustainable intermodal transport solutions.

**Project information//**  
[www.future-mobility.eu](http://www.future-mobility.eu)  
[www.iat.eu](http://www.iat.eu)



**Contact//**  
 Dipl.-Kff. Judith Terstriep  
 Institut Arbeit und Technik, IAT  
 [Institute for Work and Technology]  
 Tel.: +49 209 1707-139  
[terstriep@iat.eu](mailto:terstriep@iat.eu)

# Business analytics for SMEs – Raising corporate value through target group-specific customer value management

Aside from growing competitive pressure, the transition from a seller's to a buyer's market leads to homogenisation of the product world, combined with a reduction in the distinguishing features between enterprises. To manage these challenges, businesses need to adopt a customer-centred approach.

## Goal of the project

Constantly increasing memory capacities and processor speeds make it possible to store and analyse increasing volumes of customer data. The key question now is what customer data and what analyses are relevant for a company's business model? It is therefore essential for strategic corporate goals to be taken into account in selection of the customer data and the analyses to be performed. The purpose of business analytics is to gain new perceptions from extensive corporate data with the aid of complex statistical analyses. To SMEs in particular, this approach appears complex, time and energy-consuming and cost-intensive. The aim of this project was, therefore, to develop a generic business analytics software system that can be easily adapted to the concrete requirements of SMEs of widely differing kinds. To achieve this goal, three generic analysis tools have been developed that enable the business model of a company to be dovetailed with the data-driven customer insight. Based on the customer insight, it is possible to develop a target group-specific customer value management approach aimed at raising the corporate value in the long term.

## Analysis tools

The analyzer makes it possible to provide descriptive customer-centred analyses quickly and easily. Questions relating to turnover distribution, the contribution margin distribution of the customers or the geographical distribution of the customers can be speedily answered. In the segmenter, the results obtained from the analyser are paired up with the company's strategic goals (business model). Depending on the relevant customer-centred

performance indicators such as customer value, customer behaviour, customer life-cycle and customer satisfaction, a one- or multi-dimensional customer segmentation is conducted. The customer segmentation permits the performance, monitoring, control and evaluation of marketing campaigns aimed at specific target groups. Predictions of future customer behaviour are computed in the forecaster. How will the customer value of the individual customers develop? What customers will migrate or become inactive? Answers to these questions can change the corporate strategy and hence be incorporated into the further development of the business model as input for strategic ideas. The close dovetailing between the corporate strategy and the data-driven customer insight enables a long-term rise in the corporate value through identification of the customer value drivers and the customer-centred marketing measures derived from this.

## Contact//

Prof. Dr. Klaus Thiel  
Institut für empirische Wirtschafts- und Sozialforschung  
[Institute for Empirical Economic and Social Research]  
Tel.: +49 2871 2155-748  
klaus.thiel@w-hs.de

Prof. Dr. Bernhard Convent  
Institut für empirische Wirtschafts- und Sozialforschung  
[Institute for Empirical Economic and Social Research]  
Tel.: +49 2871 2155-816  
bernhard.convent@w-hs.de

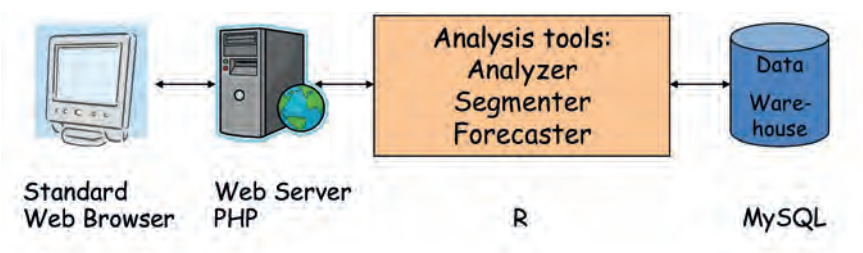

## Architectural overview

The generic architecture uses open-source components for creating the analysis tools.



# Biofunctionalisation of surfaces with proteins

## Molecular building blocks from the bionanotechnology domain

The development of highly biocompatible surfaces for medical implants using the principles of biomimetics is one of the research goals of the Laboratory of Biophysics in Recklinghausen. The aim is to combine the advantages and benefits of the body's own biomolecules with those of synthetic materials. Biomimetic modification of implant surfaces with the aid of highly specific protein molecules can encourage faster ingrowth of the implant. One such adhesion-promoting protein is the extracellular glycoprotein fibronectin. Fibronectin is a flexible protein that is able to take on different structures depending on the ambient conditions, namely a globular (spherical) conformation and a linear conformation. Fibronectin (Fn) exists in the extracellular membrane in the form of fibres and is only bioactive in this unfolded, linear conformation.

### Bio-nanofunctionalised surface

First of all, the activated TiOx surface of a first molecular layer (monolayer) is modified with trimethoxysilane molecules. A biotin group is then covalently attached to this silane layer in order to facilitate the adsorption of a streptavidin monolayer. Fibronectin can be synthetically biotinylated. Biotinylated fibronectin (bFn) bonds to streptavidin, a protein with four binding sites for biotin based on the "key & lock" principle.

### Results

On a streptavidin monolayer, biotinylated Fn has an unfolded, linear structure that possesses higher cell affinity than globular Fn applied directly to TiOx implant surfaces. On surfaces modified as far as the streptavidin monolayer, no cell adhesion occurs over a long period of time. The effect discovered here means that a surface which is biofunctionalised with streptavidin is fundamentally biologically inert. Only synthetically biotinylated proteins (e.g., as in the present case, bFn) are able to bond specifically to such surfaces. The adsorption of other proteins or the unwanted, non-specific bonding of other proteins, on the other hand, is completely suppressed.

### Conclusions

In summary, this research shows the special suitability of a bFn-streptavidin layer for coating implants. This approach is fundamentally also utilisable with other biomolecules (e.g. growth factors etc.) on many different medical implants (e.g. for use in plastic surgery or trauma surgery).

### Project information//

Project partner: Universitätsmedizin Mainz (Oral and Maxillo-Facial Surgery, Plastic Surgery)  
Supported by the Federal Ministry of Education and Research, FKZ 1775x05 and FKZ 1775x05P.

### Contact//

Prof. Dr. Michael Veith  
Westfälisches Institut für Gesundheit  
[Westphalian Institute of Health]  
Tel.: +49 2361 915-486  
michael.veith@w-hs.de

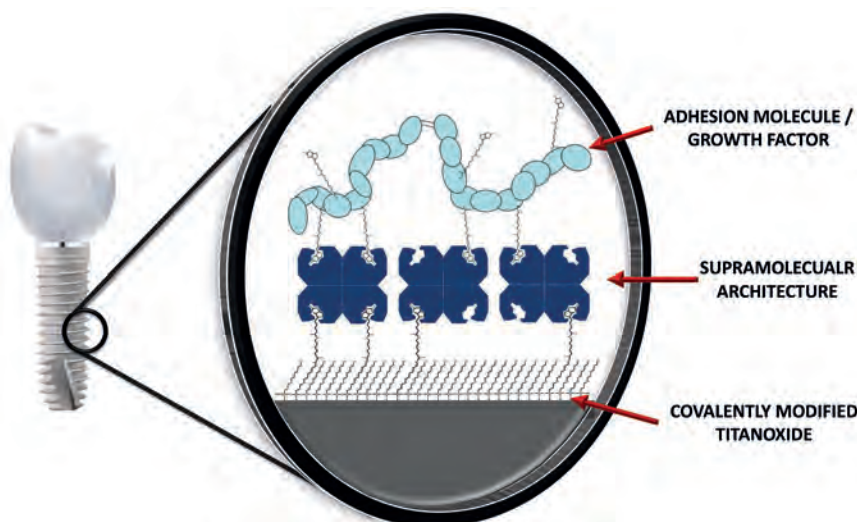

### Sequential structure principle of the supramolecular architecture

Accretion of adhesion molecules (e.g. biotinylated fibronectin (bFn)) on the "key & lock principle" through intermediate monolayers of organic molecules to the covalently modified titanoxide surface of the implant.

# The Westphalian Institute of Health

## at the Westphalian University of Applied Sciences

The Westphalian Institute of Health (“Westfälisches Institut für Gesundheit”), known as “WIGE” for short, was founded in 2012 as an interdisciplinary research and development institute of the Westphalian University of Applied Sciences (“Westfälische Hochschule Gelsenkirchen, Bocholt, Recklinghausen”). As a cross-cutting institute embracing various disciplines and areas of research, it provides a platform for transdisciplinary scientific exchange and collaboration and at the same time forms a link between science and practice.

### Transdisciplinary collaboration

In the field of health research, therefore, WIGE represents an approach towards transdisciplinary collaboration that is almost unique in the field of German health research. It brings together an unusually large range of scientific disciplines – medicine, nursing, the health-care system, physics, biology, informatics, health economics, management, sociology, political science, engineering – while at the same time having a strong down-to-earth, practical orientation. As a result, WIGE is able, firstly, to mobilise scientific expertise from a wide variety of specialist fields. And secondly, it enables new solutions in the areas of medicine, medical equipment, the life sciences or the health sciences to be looked at from the standpoint of different disciplines, i.e. in an integrated way.

### Research and testing

Thanks to the transdisciplinary collaboration between several scientific disciplines, the institute contributes to enabling potential uses and risks of new processes and products to be identified early on and also to making promising new solutions available for the enhancement of health and quality of life more quickly. Only if, in the field of experimental research, consideration is also given to new approaches for testing new products and processes (clinical trials) and also for the licensing and subsequent diffusion of them – from acceptance to financing – is finding efficient solutions and achieving rapid implementation a feasible possibility.

With this objective in mind, the WIGE not only relies on the specialist excellence of individual researchers or research teams, but also works within the logic of a complex networked and integrated innovation pathway. This transdisciplinary competence, which is a rarity in Germany, is available both to the researchers at WIGE itself and is also offered as a scientific service to third parties. The key research focuses at the institute are “Biofunctionalised Structures”, “Biomedical Modelling and Simulation”, “Technologies for Molecular Medicine”, “Care Structures and Management” and “Trustworthy Health IT”.

### Objectives of the institute

The main goal of WIGE is to subject innovative products and services resulting from the health-related research at the Westphalian University of Applied Sciences to holistic review, with the aim of achieving improved implementation, better health management and care systems, the cultivation of national and international contacts (e.g. the German-Southeast Asian research cooperation at the IAT, Institut Arbeit und Technik [Institute for Work and Technology]) and the creation of appropriate further education/training programmes. Possible projects for transdisciplinary research activities can be seen, for example, in the development of new care concepts, telemedicine, the use of ultrasound in medical equipment, ambient-assisted living, rare diseases, etc.

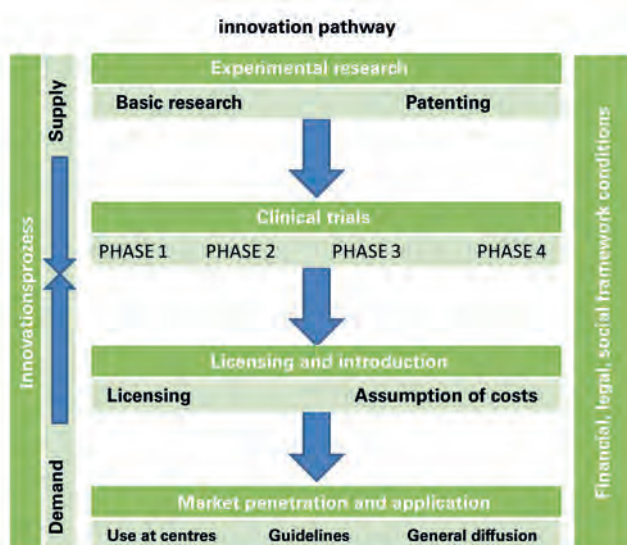

Copyright: IAT

Thanks to the “innovation pathway” in the development of innovative medical, technical, biotechnical and also organisational solutions, attention is paid at the same time to the framework conditions for launching them successfully on the market, i.e. in relation to health and quality of life, social and economic impact, obstacles, opportunities and conditions for their application, realisation and diffusion.

### Contact//

Westfälisches Institut für Gesundheit  
[Westphalian Institute of Health]  
Tel.: +49 209 1707-173  
[www.gesundheit.w-hs.de](http://www.gesundheit.w-hs.de)



**Publisher//**

Westfälische Hochschule  
Neidenburger Straße 43  
45897 Gelsenkirchen

**Responsible//**

Prof. Dr. Michael Brodmann  
Vice-President Research and Development

**Editing staff//**

Westfälische Hochschule  
Technologietransfer  
Felicia Plantikow-Voßgätter  
Dr. Elisabeth Birkenstaedt  
[www.technologietransfer.w-hs.de](http://www.technologietransfer.w-hs.de)

**Graphic design//**

Jutta Ritz

**Photos/illustrations//**

Westfälische Hochschule

**Printing//**

Clasen GmbH, Düsseldorf